

(No Model.)

3 Sheets—Sheet 1.

D. B. HUTTON & A. F. G. DANIELS.
DRILL FOR DRILLING SQUARE HOLES.

No. 456,258.

Patented July 21, 1891.

Fig. 1.

Fig. 2.

Fig. 5.

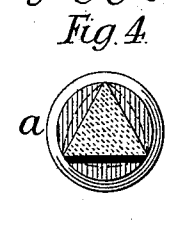
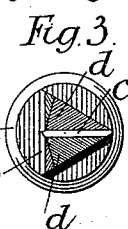
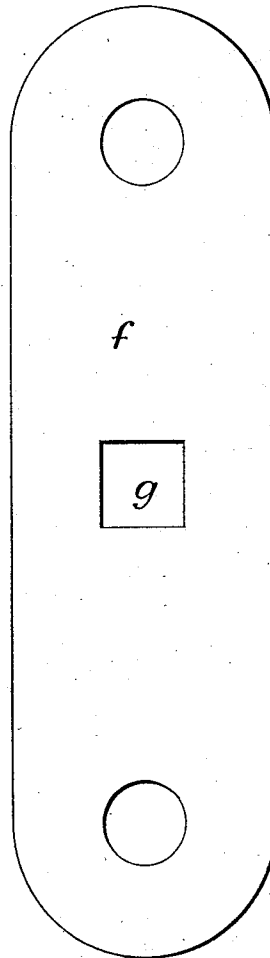
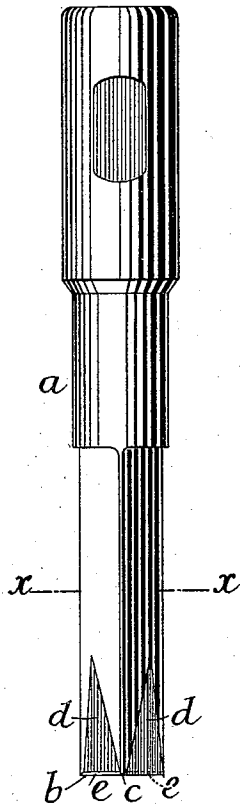
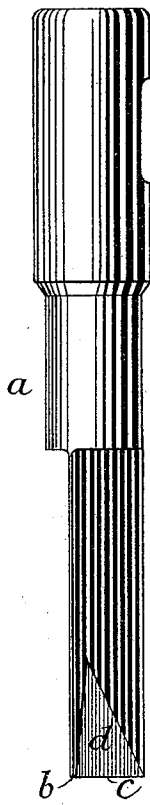

Witnesses.
John E. Dousfield.
B. Brady

Inventors.
D. B. Hutton
A. F. G. Daniels

D. B. HUTTON & A. F. G. DANIELS.
DRILL FOR DRILLING SQUARE HOLES.

No. 456,258.

Patented July 21, 1891.

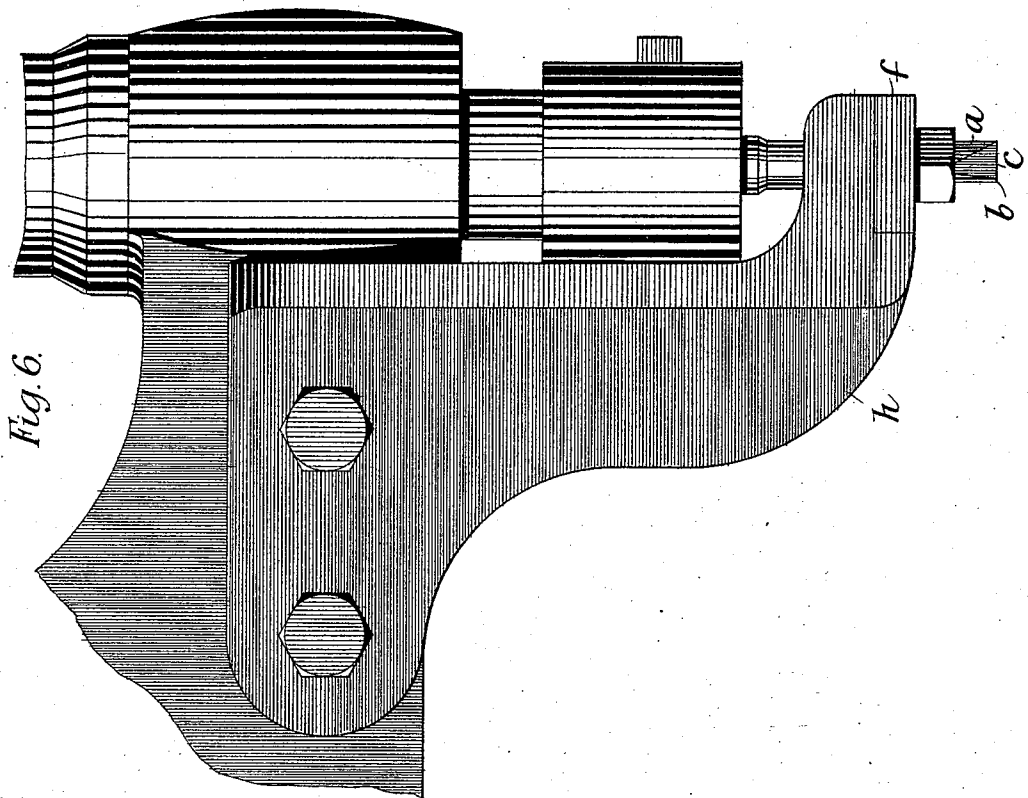
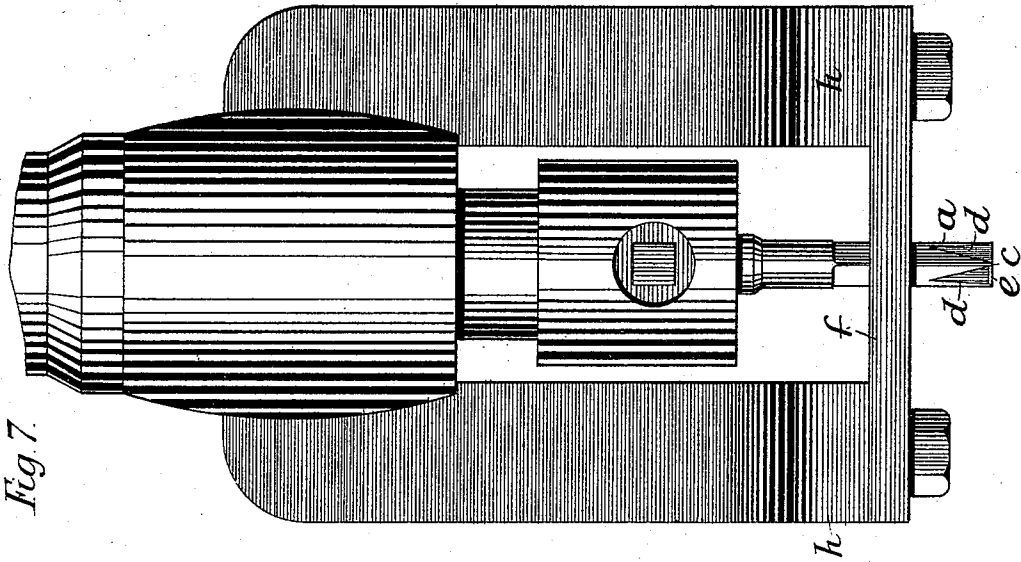

Witnesses
John E. Dousfield.
B. Brady

Inventors
D. B. Hutton
A. F. G. Daniels

(No Model.)

3 Sheets—Sheet 3.

D. B. HUTTON & A. F. G. DANIELS.
DRILL FOR DRILLING SQUARE HOLES.

No. 456,258.

Patented July 21, 1891.

Fig. 8.

Fig. 9.

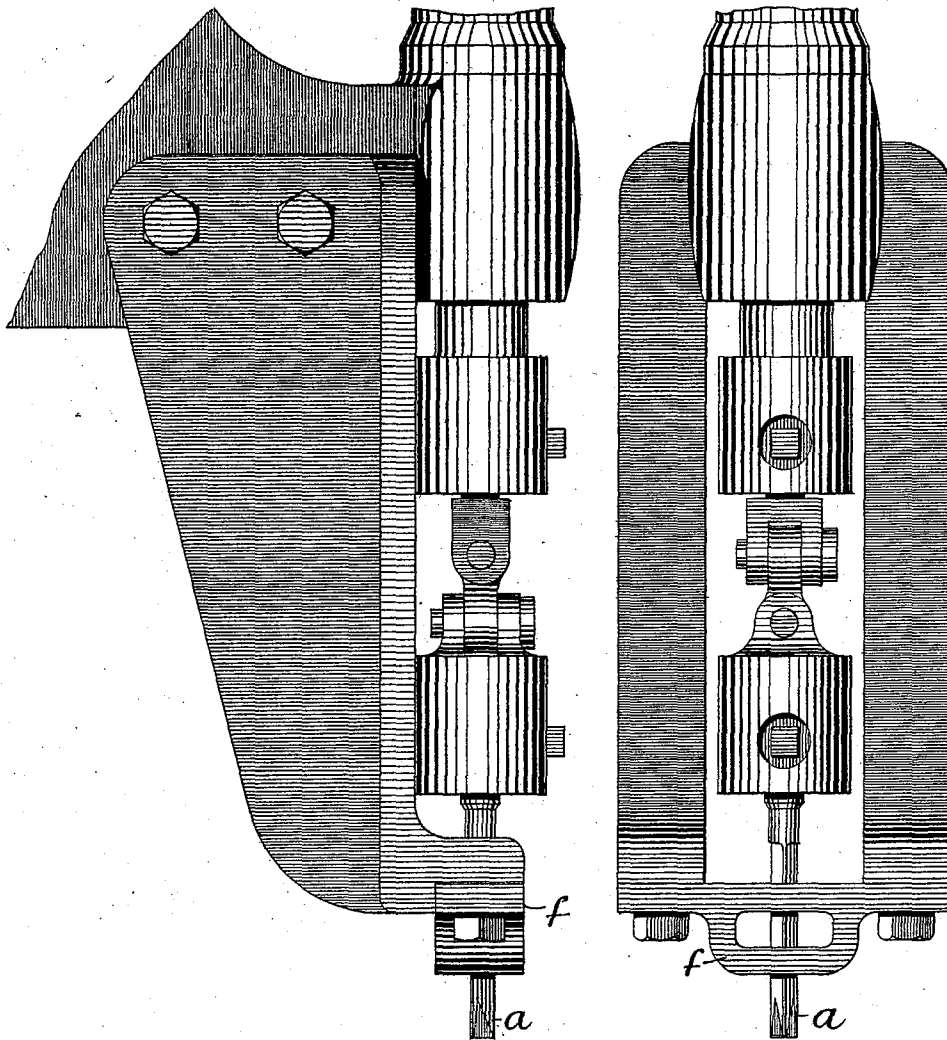

Witnesses
John E. Dougfield.
B. Brady

Inventors.
D. B. Hutton
A. F. G. Daniels.

UNITED STATES PATENT OFFICE.

DAVID BROWN HUTTON AND ARCHIBALD FREDERICK GEORGE DANIELS,
OF ESSEX, ENGLAND.

DRILL FOR DRILLING SQUARE HOLES.

SPECIFICATION forming part of Letters Patent No. 456,258, dated July 21, 1891.

Application filed February 3, 1891. Serial No. 380,105. (No model.)

To all whom it may concern:

Be it known that we, DAVID BROWN HUTTON and ARCHIBALD FREDERICK GEORGE DANIELS, subjects of the Queen of Great Britain, residing at Essex, England, have invented new and useful Improvements in and Connected with Drills for Drilling Square Holes, of which the following is a specification.

This invention relates to drills which may be applied to drilling-machines, lathes, and the like for drilling square holes, the said drills being of triangular or substantially triangular shape in transverse section, but having their sides slightly curved or rounded, and having a single cutting-edge extending across the end of the same and used in combination with a guide-plate having a square hole.

In the accompanying drawings, Figure 1 is an elevation of a drill constructed according to our invention, and Fig. 2 is a view of the same in a position at right angles to that shown in Fig. 1. Fig. 3 is a view of the cutting end of the said drill; and Fig. 4 is a section on the line *xx*, Fig. 2. Fig. 5 is the view of the guide-plate. Figs. 6 and 7 are a side and front elevation, respectively, illustrating the application of our improved drill to an ordinary vertical spindle drilling-machine; and Figs. 8 and 9 are side and front views illustrating a modification.

Similar letters of reference indicate corresponding parts in the several figures.

a indicates our improved drill, one end of which is of cylindrical shape, as shown, or otherwise suitably shaped to fit the socket of the drilling-machine, lathe, or the like in which it is to be used, while the lower part or shank, which is of triangular shape, but with slightly-rounded sides, as hereinbefore stated, is made of any desirable length, according to requirements. These rounded sides are found in practice to have a very decided advantage, as they prevent a considerable amount of jarring which takes place when a flat-sided drill is employed. The end of the triangular shank is ground or beveled off to form one or more cutting-edges, but in such a manner that the drill shall have no central point upon which it can rotate.

As shown in Figs. 1 to 3, the drill may be provided with the cutting-edge *b* on one of the triangular sides and with another cutting-edge *c* at right angles thereto, the latter being formed by notching the other two sides of the triangular shank, as shown at *d d*. The halves of the edge *b* are beveled in opposite directions, as indicated most clearly in Fig. 2 at *e e*, and the edge *c* is also beveled in such a manner that during the rotation of the drill it will cut with the other edge. In some cases the edge *c* is dispensed with, in which case the whole of the cutting is effected by the edge *b*.

f is the guide-plate through which the drill works, the said guide-plate being provided with a square hole *g*, the sides of which are of slightly-greater length than the sides of the triangular shank, the result of which arrangement is that when the drill is rotated in the hole in the guide-plate the angles of the said drill will be caused to enter the angles of the said hole, and thus insure the cutting out of the whole surface exposed inside the hole. This guide-plate may be fixed to the table of a drilling-machine or attached to the rest of a lathe or to the article to be drilled; or it may be carried by brackets *h h*, bolted to the frame of the drilling-machine, as indicated in Figs. 6, 7, 8, and 9. It is obvious that when rotating in the hole of the guide-plate the drill will have no central point, and it is therefore necessary to provide for a slight lateral play of the drill. This may be advantageously accomplished either by allowing the drill to fit loosely in the socket of the drilling-machine spindle or by mounting the drill in an independent socket carried upon the drill-spindle by means of a universal joint, as shown in Figs. 8 and 9. In this latter case, however, the guide-plate *f* is made of greater depth than that hereinbefore described, (for instance, in the manner shown in the said Figs. 8 and 9,) so as to hold the drill at two points in its length.

Although we have described our improved drill as applied for drilling square holes, it is obvious that if the drill is used without the guide and is rigidly fastened in the socket of the drilling-machine it will drill round holes.

The curved or round form of the sides of the triangular-drill shank is shown in dotted lines in Fig. 4.

Having now particularly described and as-
5 certained the nature of our said invention and in what manner the same is to be performed, we declare that what we claim is—

1. A triangular drill having rounded sides and having a single cutting-edge extending
10 across and bisecting the end of the same.
2. In combination with a drill-socket hav-

ing a universal joint, a triangular drill having rounded sides and a cutting-edge extending across the end of the same.

DAVID BROWN HUTTON.

ARCHIBALD FREDERICK GEORGE DANIELS.

Witnesses:

JOHN E. BONSFIELD,

*Of the firm of G. F. Redfern & Co., 4 South
Street, Finsbury, London, Patent Agents.*

W. C. BROKENSHERE.